

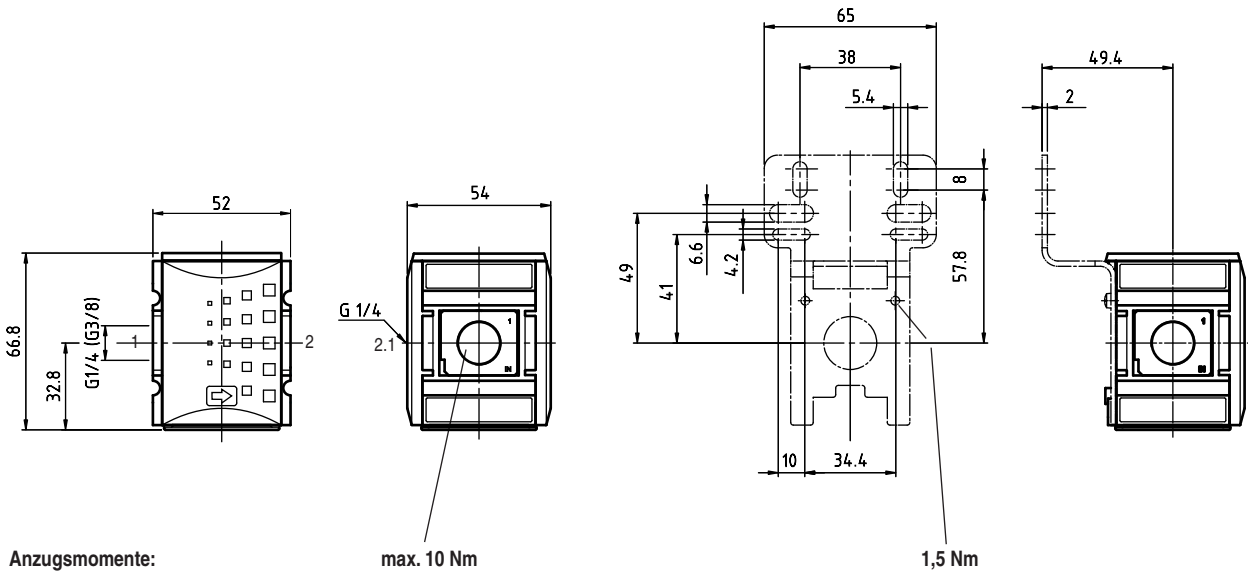

## Abmessungen (mm)

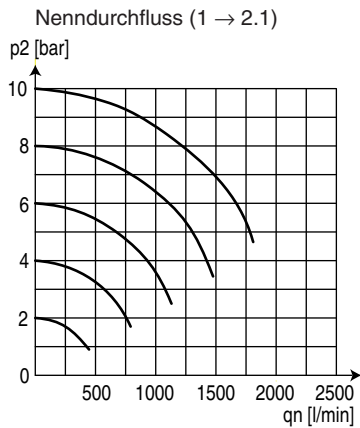

## Durchflusscharakteristik

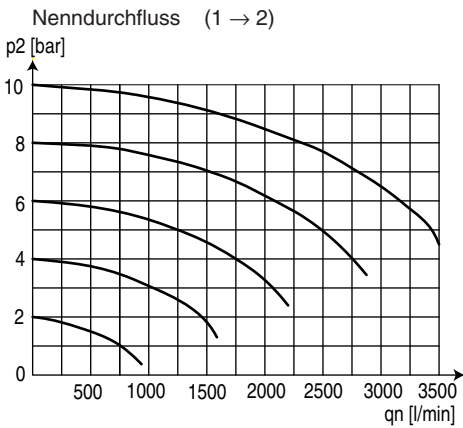

## Zubehör 2

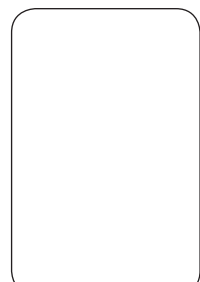
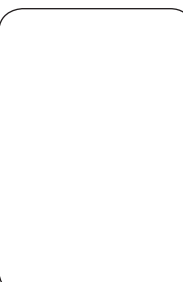
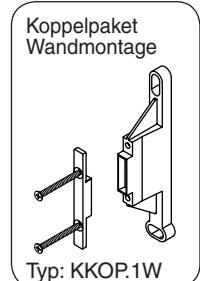
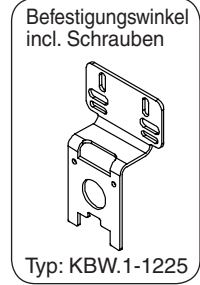
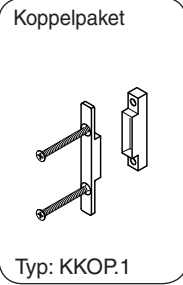

## Einsatzbeispiel

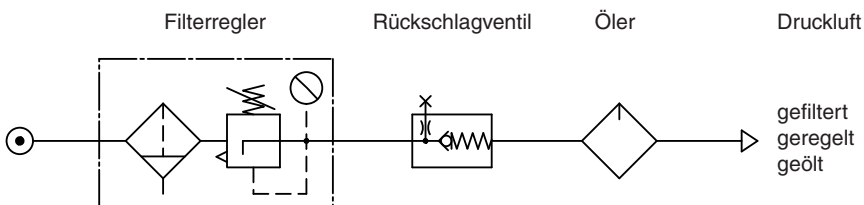

Technische Änderungen vorbehalten!

Blatt: KREV-1 (02/09)